

OPzV12-60(12V60Ah)



OPzV series is Valve Regulated Lead Acid battery that adopts immobilized GEL and Tubular Plate technology to offer high reliability and performance. The Battery is designed and manufactured according to DIN standards and with die-casting positive grid and patented formula of active material OPzV series exceeds DIN standard values with more than 20 years floating design life at 25 °C and It is the best solution for cyclic use under extreme operating conditions.

Specification

Cells Per Unit	6
Voltage Per Unit	2
Nominal Capacity	60Ah@10hr-rate to 1.80V per cell @25°C
Weight	Approx. 23.0Kg (Tolerance±3.0%)
Internal Resistance	Approx. 15.0 mΩ
Terminal	F11(M6)
Max. Discharge Current	600A (5 sec)
Design Life	18 years (floating charge)
Max. Charging Current	12.0 A
Reference Capacity	C3 47.1AH C5 52.8AH C10 60.0AH C20 64.3AH
Float Charging Voltage	13.5 V~13.8 V @ 25°C Temperature Compensation: -3mV/°C/Cell
Cycle Use Voltage	14.2 V~14.4 V @ 25°C Temperature Compensation: -4mV/°C/Cell
Operating Temperature Range	Discharge: -40°C~60°C Charge: -20°C~50°C Storage: -40°C~60°C
Normal Operating Temperature Range	25°C±5°C
Self Discharge	RITAR Valve Regulated Lead Acid (VRLA) batteries can be stored for up to 6 months at 25°C and then recharging is recommended. Monthly Self-discharge ratio is less than 2% at 20°C. Please charged batteries before using.
Container Material	A.B.S. UL94-HB, UL94-V0 Optional.



Dimensions

Unit: mm

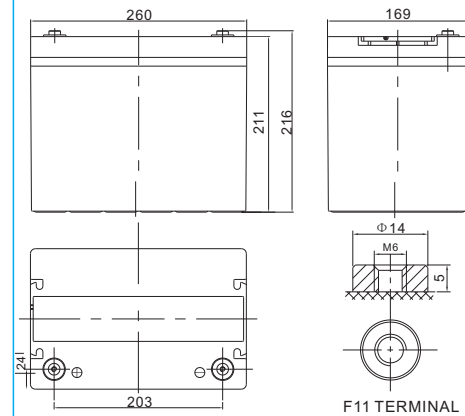

Length	260±2mm (10.2 inches)
Width	169±2mm (6.65 inches)
Height	211±2mm (8.31 inches)
Total Height	216±2mm (8.50 inches)
Torque Value	10~12 N*m

Constant Current Discharge Characteristics : A(25°C)

F.V/ Time	10min	15min	30min	1h	2h	3h	5h	8h	10h	20h
1.60V	98.20	78.80	52.18	35.93	22.26	17.25	11.34	7.64	6.420	3.371
1.65V	92.06	74.50	50.31	34.87	21.54	16.88	11.10	7.52	6.300	3.308
1.70V	84.19	69.43	48.09	33.69	20.82	16.32	10.86	7.398	6.180	3.245
1.75V	77.06	63.96	44.93	31.93	20.10	15.69	10.56	7.278	6.120	3.213
1.80V	67.16	57.21	41.77	29.99	19.14	15.01	10.20	7.098	6.000	3.150
1.85V	55.87	49.53	37.21	27.34	17.70	14.01	9.713	6.797	5.742	3.015

Constant Power Discharge Characteristics : WPC(25°C)

F.V/ Time	10min	15min	30min	1h	2h	3h	5h	8h	10h	20h
1.60V	154.0	127.8	95.88	68.09	42.54	33.20	22.08	15.10	12.66	6.647
1.65V	150.1	125.2	93.37	66.44	41.34	32.63	21.66	14.86	12.48	6.552
1.70V	142.4	120.4	90.15	64.68	40.20	31.64	21.24	14.68	12.30	6.458
1.75V	129.2	111.7	85.00	61.50	39.00	30.64	20.75	14.44	12.18	6.395
1.80V	111.2	101.3	79.74	58.09	37.26	29.27	20.03	14.08	11.94	6.269
1.85V	91.95	84.97	71.60	53.21	34.56	27.40	19.12	13.47	11.46	6.017

(Note) The above characteristics data are average values obtained within three charge/discharge cycle not the minimum values.

The battery must be fully charged before the capacity test. The C₁₀ should reach 95% after the first cycle and 100% after the third cycle.

Discharge Characteristics Curve

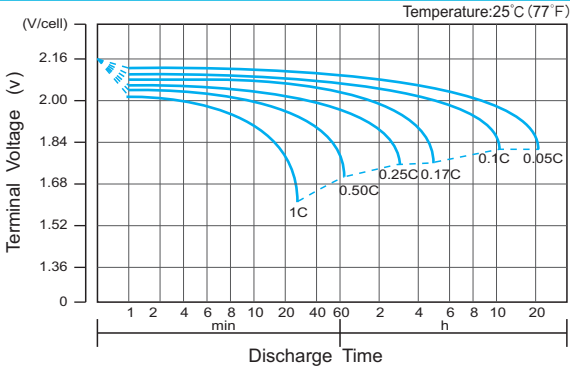

Charge Characteristic Curve for Cycle Use(IU)

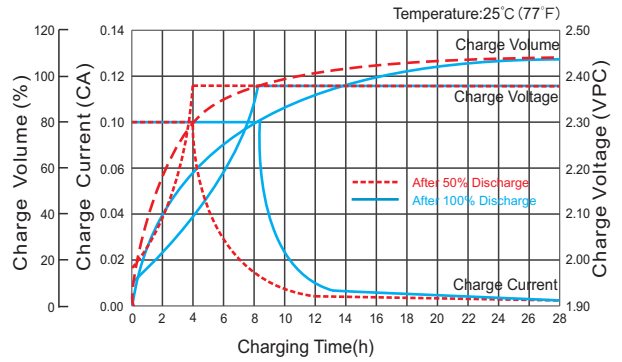

Cycle Life in Relation to Depth of Discharge

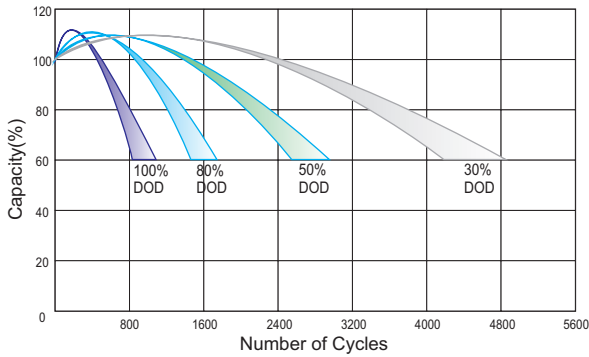

Relationship Between Charging Voltage and Temperature

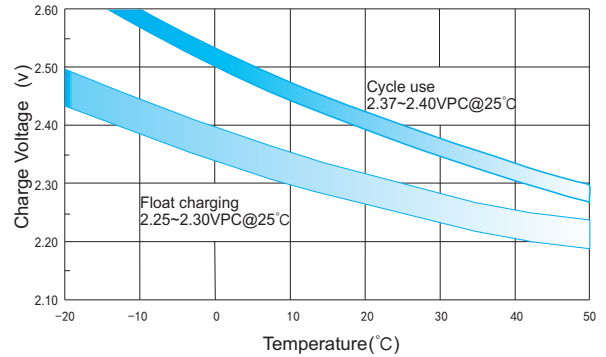

Temperature Effects on Capacity

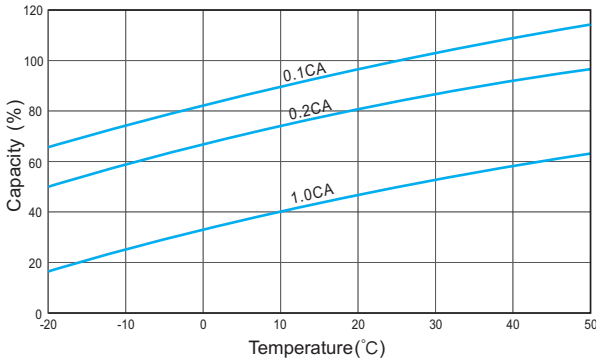

Storage Characteristics

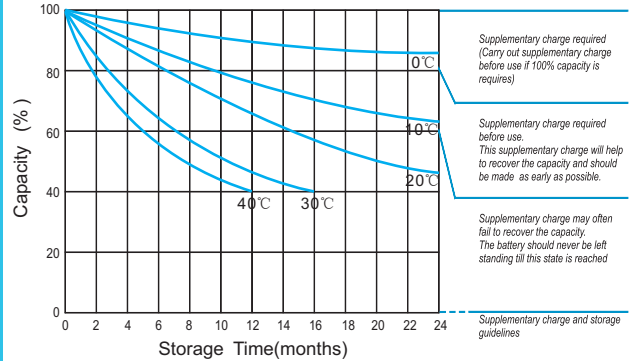

Effect of Temperature on Long Term Life

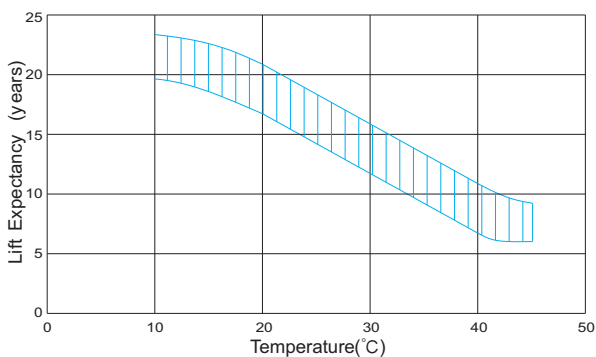

Relationship of OCV And State of Charge(20°C)

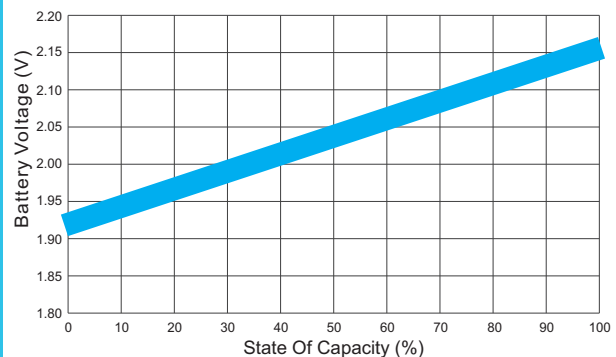

(Note) All above information shall be changed without prior notice, Ritar reserves the right to explain and update the latest information.