



# OPzV2-200(2V200Ah)



OPzV series is Valve Regulated Lead Acid battery that adopts immobilized GEL and Tubular Plate technology to offer high reliability and performance. The Battery is designed and manufactured according to DIN standards and with die-casting positive grid and patented formula of active material OPzV series exceeds DIN standard values with more than 25 years floating design life at 25 °C and It is the best solution for cyclic use under extreme operating conditions.



## Specification

<b>Cells Per Unit</b>	1
<b>Voltage Per Unit</b>	2
<b>Nominal Capacity</b>	200Ah@10hr-rate to 1.80V per cell @25°C
<b>Weight</b>	Approx. 16.0Kg (Tolerance ± 3.0%)
<b>Internal Resistance</b>	Approx. 1.0 mΩ
<b>Terminal</b>	F10(M8)
<b>Max. Discharge Current</b>	1000A (5 sec)
<b>Design Life</b>	25 years
<b>Max. Charging Current</b>	40.0 A
<b>Reference Capacity</b>	C3 153.6AH C5 173.7AH C10 200.0AH C20 213.2AH
<b>Float Charging Voltage</b>	2.25 V~2.30 V @ 25°C Temperature Compensation: -3mV/°C/Cell
<b>Cycle Use Voltage</b>	2.37 V~2.40 V @ 25°C Temperature Compensation: -4mV/°C/Cell
<b>Operating Temperature Range</b>	Discharge: -40°C~60°C Charge: -20°C~50°C Storage: -40°C~60°C
<b>Normal Operating Temperature Range</b>	25°C ± 5°C
<b>Self Discharge</b>	RITAR Valve Regulated Lead Acid (VRLA) batteries can be stored for up to 6 months at 25°C and then recharging is recommended. Monthly Self-discharge ratio is less than 2% at 20°C. Please charged batteries before using.
<b>Container Material</b>	A.B.S. UL94-HB, UL94-V0 Optional.

## Dimensions

Unit: mm

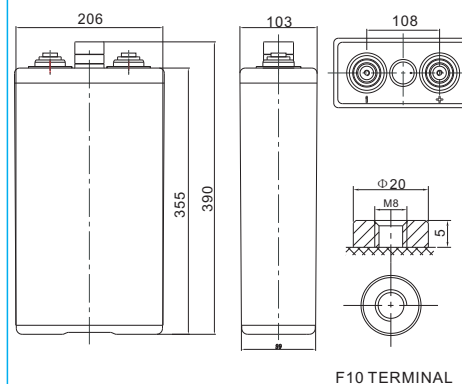

Length	103±2mm (4.06 inches)
Width	206±2mm (8.11 inches)
Height	355±2mm (14.0 inches)
Total Height	390±2mm (15.4 inches)
Torque Value	10~12 N*m

### Constant Current Discharge Characteristics : A(25°C)

F.V/ Time	10min	15min	30min	1h	2h	3h	5h	8h	10h	20h
1.60V	314.6	251.8	171.3	113.2	72.21	53.77	36.12	24.95	20.90	10.97
1.65V	300.5	242.7	167.3	111.5	71.11	53.17	35.82	24.75	20.70	10.87
1.70V	280.4	230.7	161.3	108.6	69.92	52.18	35.22	24.45	20.60	10.82
1.75V	249.2	210.6	152.3	104.1	68.23	51.19	34.73	24.15	20.30	10.66
1.80V	211.1	188.6	142.3	100.1	65.94	50.10	34.03	23.75	20.00	10.50
1.85V	171.9	155.5	122.2	89.31	60.16	46.03	31.54	22.16	18.70	9.818

### Constant Power Discharge Characteristics : WPC(25°C)

F.V/ Time	10min	15min	30min	1h	2h	3h	5h	8h	10h	20h
1.60V	534.7	440.3	311.6	212.2	137.0	102.9	69.95	48.90	41.30	21.68
1.65V	521.6	431.3	307.6	209.9	135.9	102.3	69.45	48.70	41.00	21.53
1.70V	494.5	414.2	298.6	205.9	133.6	100.6	68.85	48.20	40.70	21.37
1.75V	448.2	385.2	284.6	199.1	130.7	98.90	67.76	47.70	40.30	21.16
1.80V	385.9	349.0	269.5	192.8	127.9	97.22	66.57	47.01	39.70	20.84
1.85V	319.6	292.9	233.5	172.3	116.9	89.78	61.99	44.01	37.30	19.58

(Note) The above characteristics data are average values obtained within three charge/discharge cycle not the minimum values.

The battery must be fully charged before the capacity test. The C<sub>10</sub> should reach 95% after the first cycle and 100% after the third cycle.

### Discharge Characteristics Curve

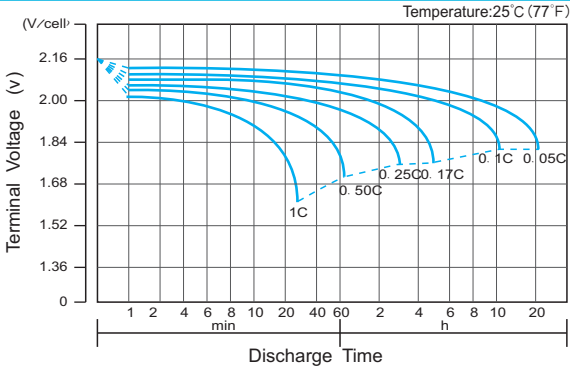

### Charge Characteristic Curve for Cycle Use(IUU)

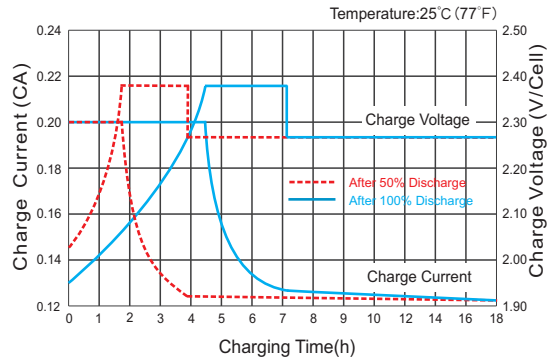

### Cycle Life in Relation to Depth of Discharge

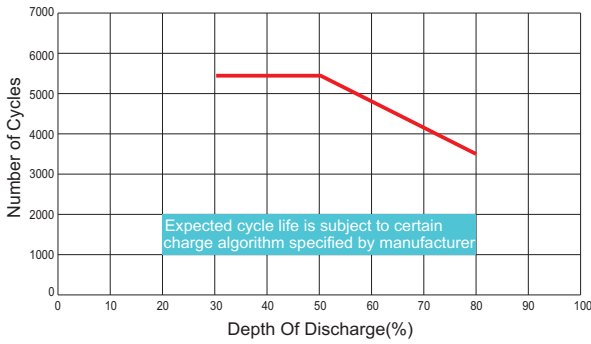

### Relationship Between Charging Voltage and Temperature

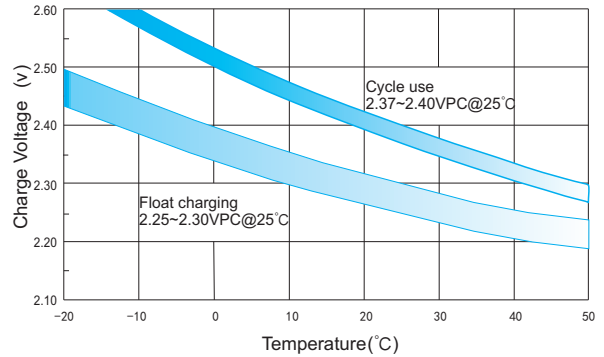

### Temperature Effects on Capacity

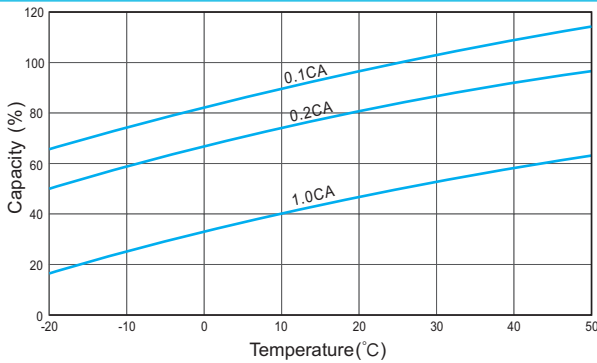

### Storage Characteristics

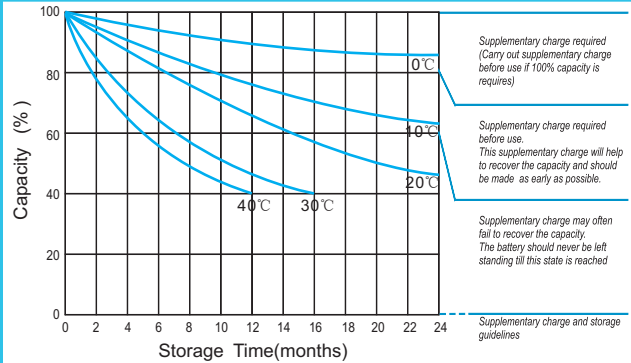

### Effect of Temperature on Long Term Life

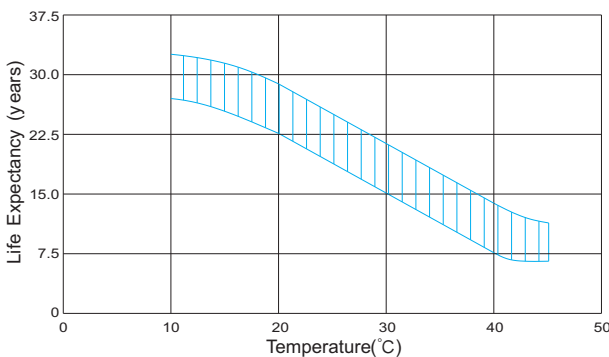

### Relationship of OCV And State of Charge(20°C)

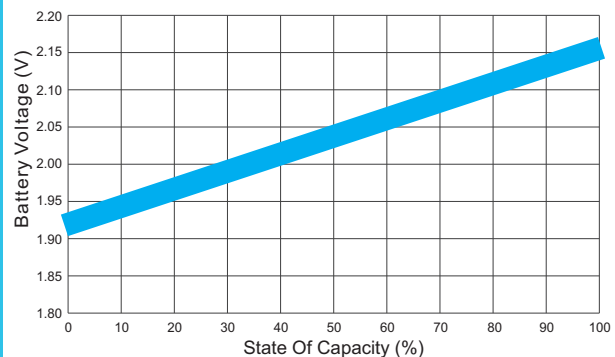

(Note) All above information shall be changed without prior notice, Ritar reserves the right to explain and update the latest information.