

IEEE/UL Battery
Sizing by
MooreU
610-952-6067
www.mooreu.com

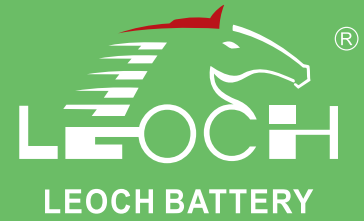

OPzS Series-Flooded Battery 6 OPzS420(2V420Ah)



Specifications

Rated Voltage	2V	
Nominal Capacity	C ₁₀ , 1.80V/cell	420.0Ah
Dimension	Length	145±2mm (5.71 inches)
	Width	206±2mm (8.11 inches)
	Container Height	471±3mm (18.54 inches)
	Total Height	526±3mm (20.71 inches)
Approx Weight	Without Electrolyte	24.5kg (54.0lbs)
	With Electrolyte	32.7 kg (72.1lbs)
Terminal	M10	
Container Material	SAN transparent container	
Rated Capacity	420.0 Ah	(10hr,42.0A,1.80V/cell)
	373.0 Ah	(5hr,74.6A,1.75V/cell)
	323.7 Ah	(3hr,107.9A,1.75V/cell)
	239.8 Ah	(1hr,239.8A,1.60V/cell)
Max. Discharge Current	3360A (5s)	
Internal Resistance (20°C)	Approx 0.88mΩ	
Operating Temp.Range	Discharge	-15 ~ 55°C (5 ~ 131°F)
	Charge	0 ~ 45°C (32 ~ 113°F)
	Storage	-15 ~ 45°C (5 ~ 113°F)
Nominal Operating Temp. Range	25±5°C (77±9°F)	
Cycle Use	Initial Charging Current less than 0.15CA. Voltage	
	2.40V~2.45V at 20°C(68°F)Temp. Coefficient -5mV/°C	
Standby Use	Initial Charging Current less than 0.15CA. Voltage	
	2.23V~2.25V at 20°C(68°F)Temp. Coefficient -3mV/°C	
Effect of temp. to Capacity	40°C (104°F)	103%
	20°C (68°F)	100%
	0°C (32°F)	86%
Self Discharge	≤4% per month at 20°C	



Layout

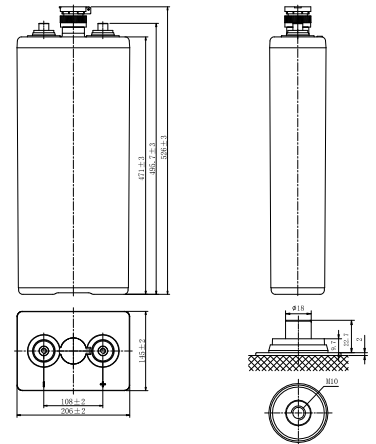

Constant Current Discharge (Amperes) at 20 °C (68°F)

F. V/Time	1h	2h	3h	4h	5h	6h	8h	10h	20h	24h	72h	100h	120h
1.85V/cell	166.7	121.8	93.8	77.7	67.0	58.9	48.0	40.2	22.1	18.5	6.65	4.99	4.27
1.80V/cell	194.9	134.2	102.5	83.9	71.5	62.5	50.5	42.0	23.0	19.3	6.92	5.19	4.45
1.75V/cell	211.7	142.8	107.9	87.7	74.6	64.9	51.9	42.9	23.4	19.6	7.04	5.28	4.52
1.70V/cell	223.0	149.1	111.4	90.4	76.6	66.5	52.8	43.7	23.8	/	/	/	/
1.65V/cell	231.8	152.7	114.8	92.5	78.3	67.8	53.7	44.4	24.1	/	/	/	/
1.60V/cell	239.8	156.2	116.8	93.9	79.4	68.7	54.4	44.9	24.4	/	/	/	/

Constant Power Discharge (Watts/cell) at 20 °C (68°F)

F. V/Time	1h	2h	3h	4h	5h	6h	8h	10h	20h	24h	72h	100h	120h
1.85V/cell	312.0	229.7	177.8	147.8	128.1	113.1	92.5	77.9	43.0	36.0	12.8	9.59	8.20
1.80V/cell	359.4	250.3	192.2	158.1	135.5	119.1	96.6	80.8	44.3	37.1	13.2	9.88	8.44
1.75V/cell	385.4	264.0	200.9	164.2	140.7	122.9	98.8	82.1	44.9	37.6	13.4	10.01	8.56
1.70V/cell	402.3	273.7	206.1	168.4	143.8	125.5	100.1	83.1	45.5	/	/	/	/
1.65V/cell	415.0	279.0	211.3	171.8	146.4	127.5	101.5	84.2	46.0	/	/	/	/
1.60V/cell	425.8	284.1	213.8	173.4	147.7	128.7	102.2	84.8	46.2	/	/	/	/



IEEE/UL Battery
Sizing by
MooreU
610-952-6067
www.mooreu.com



OPzS Series-Flooded Battery

6 OPzS420(2V420Ah)

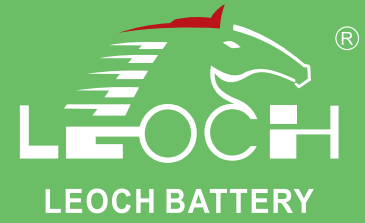

Applications

- Telecommunications
- Buoy lighting
- Standby power
- Railway signalling
- Emergency lighting systems
- Alternative power (solar, wind)
- Maritime standby power on ships and ashore

General Features

- 20 years design life(20°C)
- Lower self discharge
- Higher thermal capacity, no thermal runaway will occur
- Superior deep cycle performance
- Wide operation temperature range

Standards

- Acc. to IEC60896, DIN 40736 standards
- Manufactured in Leoch@IATF 16949, ISO 45001, ISO 9001 and ISO 14001 certified production facilities

Discharge Characteristics

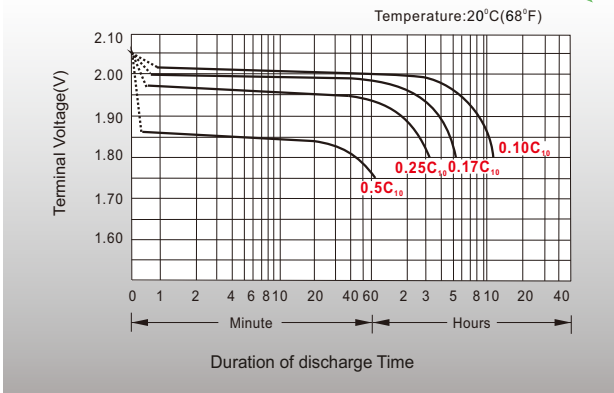

Charge voltage Vs ambient temperature curve

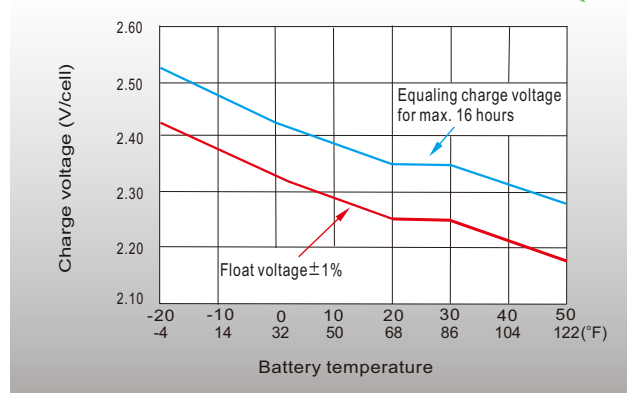

Discharge capacity Vs Ambient temperature curve (10A)

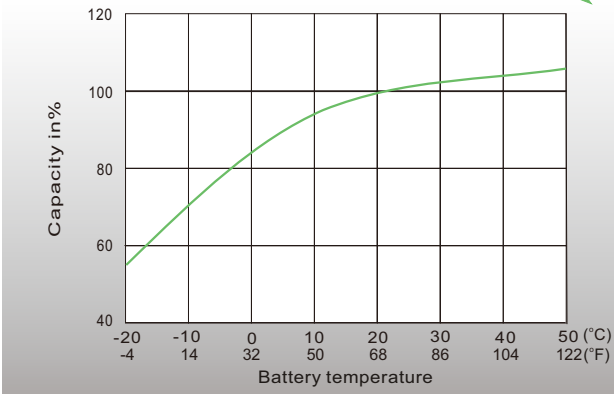

Effect of Temperature on Long Term Float Life

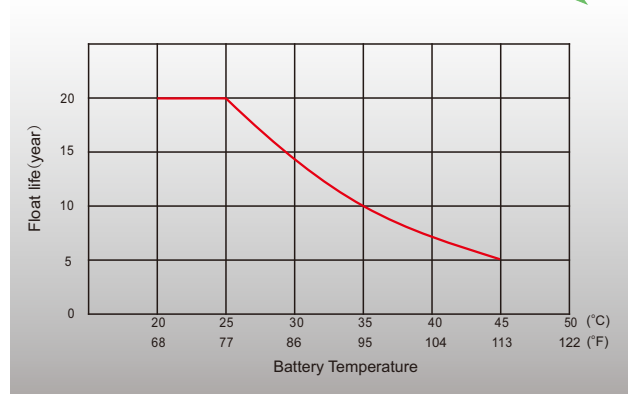

Sales Offices Worldwide

China Sales Office

5th Floor, Xinbaohui Bldg., Nanhai Blvd.,
Nanshan, Shenzhen, China. 518052
Tel: +86-755-86036060 (100 lines)
Fax: +86-755-26067269
E-mail: export@leoch.com

HongKong Sales Office

Workshop C, 33/F, TML Tower, No. 3 Hoi Shing Road,
Tsuen Wan, New Territories, Hong Kong
Tel: +852 35786666
Fax: +44 1452 690125
E-mail: sales.hk@leoch.com

Singapore Sales Office

No. 1 Tech Park Crescent,
Singapore 638131
Tel: +65 68636078
Fax: +65 6863 6079
Email: sales.sg@Leoch.com

Australia Sales Office

2/29 Tarlington Place, Smithfield. NSW 2164
Australia
Tel: 02 9756 0950
E-mail: sales.au@leoch.com

North America Sales Office

19751 Descartes
Foothill Ranch, CA 92610, USA
Tel: 949-588-5853
Fax: 949-588-5966
E-mail: sales@leoch.us

UK Sales Office

9B Wheatstone Court, Waterwells, Business Park,
Gloucester, GL2-2AQ, UK United Kingdom
Tel: +44(0) 1452 729428 / 1452 729696
Fax: +44 1452 690125
E-mail: Sales.Europe@leoch.com

EMEA Sales Office

1 Deligiorgi St., 121 31 Athens,
Greece
Tel: +30 210 5760318 (2 lines)
E-mail: support_EMEA@leoch.com

India Sales Office

Shed no.A-53(b), 2nd Stage of Peenya Industrial Area,
Bangalore North Taluk, Bangalore-560058, India
Tel: +91-80-23440018/23440019
Fax: +91-80-23440017
E-mail: indiasales@leoch.com



[Http://www.leoch.com](http://www.leoch.com)

[Http://www.leoch.us](http://www.leoch.us)

© 2022 LEOCH. All rights reserved.

Trademarks and logos are the property of LEOCH and its affiliates unless otherwise noted.
Subject to revisions without prior notice.

Publication No.:LB-6 OPzS420-PD-EN-V2.1-202205