

# OPzV2-300(2V300Ah)



Ritar OPzV series is Valve Regulated Lead Acid battery that adopts immobilized GEL and Tubular Plate technology to offer high reliability and performance. The Battery is designed and manufactured according to DIN standards and with die-casting positive grid and patented formula of active material OPzV series exceeds DIN standard values with more than 20 years floating design life at 25 °C ,and It is the best solution for cyclic use under extreme operating conditions.

## Specification

<b>Cells Per Unit</b>	1
<b>Voltage Per Unit</b>	2
<b>Nominal Capacity</b>	300Ah@10hr-rate to 1.80V per cell @25°C
<b>Weight</b>	Approx. 24.5 Kg (Tolerance±2%)
<b>Internal Resistance</b>	Approx. 0.85 mΩ
<b>Terminal</b>	F10(M8)
<b>Max. Discharge Current</b>	1350A (5 sec)
<b>Design Life</b>	20 years (floating charge)
<b>Maximum Charging Current</b>	60.0 A
<b>Reference Capacity</b>	C3 227.0AH C5 255.0AH C10 300.0AH C20 321.3AH
<b>Float Charging Voltage</b>	2.25 V~2.30 V @ 25°C Temperature Compensation: -3mV/°C/Cell
<b>Cycle Use Voltage</b>	2.37 V~2.40 V @ 25°C Temperature Compensation: -4mV/°C/Cell
<b>Operating Temperature Range</b>	Discharge: -40°C~60°C Charge: -20°C~50°C Storage: -40°C~60°C
<b>Normal Operating Temperature Range</b>	25°C±5°C
<b>Self Discharge</b>	RITAR Valve Regulated Lead Acid (VRLA) batteries can be stored for up to 6 months at 25°C and then recharging is recommended. Monthly Self-discharge ratio is less than 2% at 25°C.Please charged batteries before using.
<b>Container Material</b>	A.B.S. UL94-HB, UL94-V0 Optional.



## Dimensions

Unit: mm

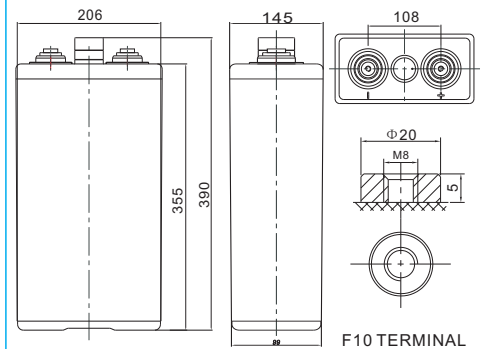

Length	145±2mm (5.71 inches)
Width	206±2mm (8.11 inches)
Height	355±2mm (14.0 inches)
Total Height	390±2mm (15.4 inches)
Torque Value	10~12 N*m

## Constant Current Discharge Characteristics : A(25°C)

F.V/ Time	30min	1h	2h	3h	4h	5h	6h	8h	10h	20h
1.90	147.6	117.0	82.50	62.58	51.30	44.34	39.90	31.14	26.70	14.02
1.87	165.0	129.0	88.50	66.36	54.15	46.62	42.30	32.59	27.90	14.65
1.83	189.0	144.0	96.00	70.71	57.00	48.66	43.80	34.05	29.10	15.28
1.80	210.0	156.0	99.60	72.75	58.14	49.80	45.00	34.92	30.00	15.75
1.75	234.0	167.1	104.1	75.66	59.10	51.00	45.90	35.50	30.60	16.07
1.70	258.0	172.5	107.1	77.13	60.14	51.60	46.50	35.79	30.90	16.22
1.65	266.1	183.3	110.7	79.20	60.99	52.20	47.10	36.08	31.20	16.38
1.60	277.5	189.6	114.9	82.50	62.70	53.10	47.70	36.38	31.50	16.54

## Constant Power Discharge Characteristics : WPC(25°C)

F.V/ Time	30min	1h	2h	3h	4h	5h	6h	8h	10h	20h
1.90	282.5	224.6	159.5	121.2	100.4	87.30	78.90	62.27	54.42	28.57
1.87	310.8	243.9	169.1	126.9	105.8	91.50	83.40	64.89	56.75	29.79
1.83	348.2	265.9	180.0	133.6	111.0	95.10	86.10	67.22	58.78	30.86
1.80	380.5	283.7	186.0	136.6	113.1	97.20	88.20	68.68	60.24	31.62
1.75	412.8	296.4	192.1	140.8	114.6	99.60	89.70	69.55	61.11	32.08
1.70	442.6	299.4	196.9	143.2	116.4	100.5	90.60	70.13	61.69	32.39
1.65	450.1	312.7	202.3	146.2	117.9	101.4	91.50	70.71	61.98	32.54
1.60	455.6	322.3	207.1	151.1	120.9	102.3	92.10	71.00	62.27	32.69

(Note) The above characteristics data are average values obtained within three charge/discharge cycle not the minimum values.

# OPzV2-300(2V300Ah)



## Discharge Characteristics Curve

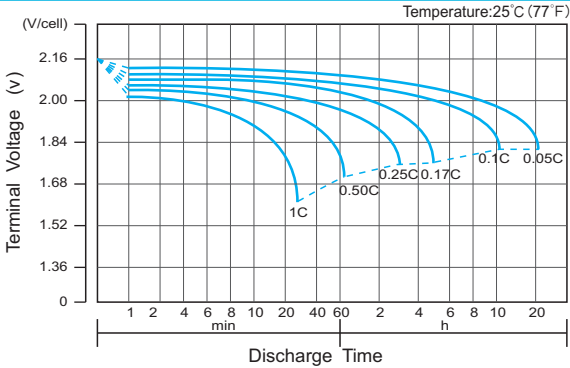

## Charge Characteristic Curve for Cycle Use(IU)

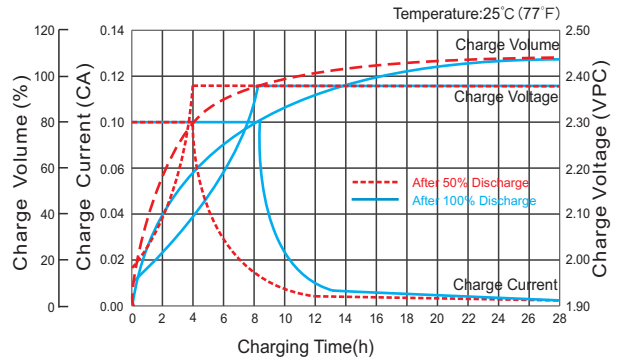

## Cycle Life in Relation to Depth of Discharge

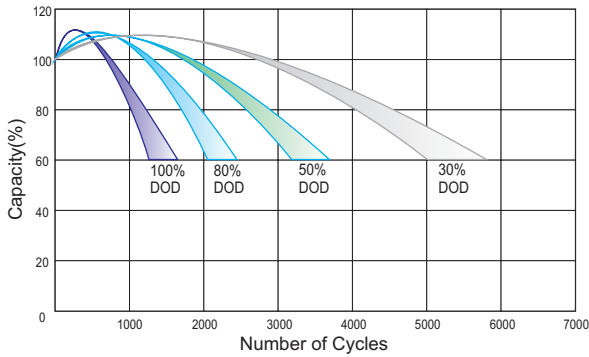

## Relationship Between Charging Voltage and Temperature

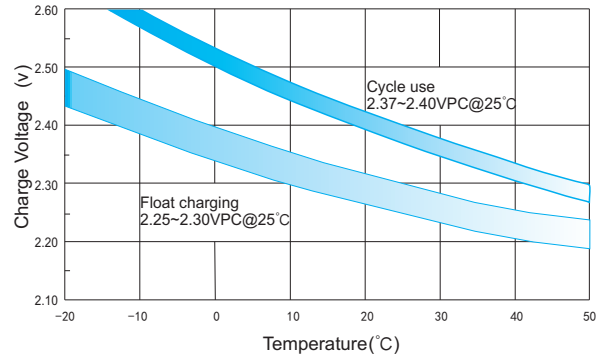

## Temperature Effects on Capacity

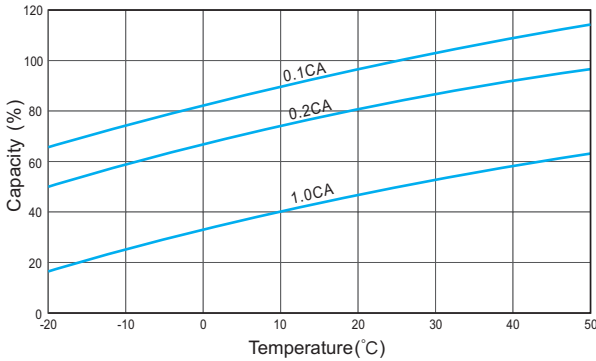

## Storage Characteristics

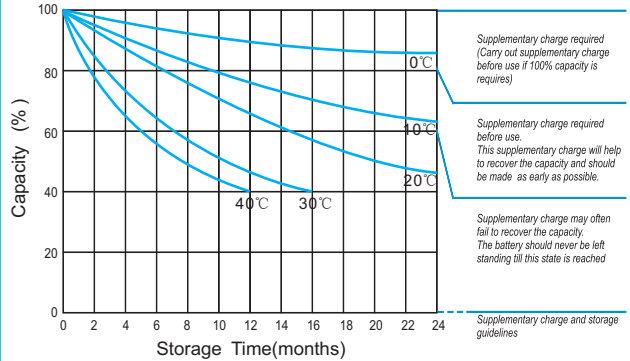

## Effect of Temperature on Long Term Life

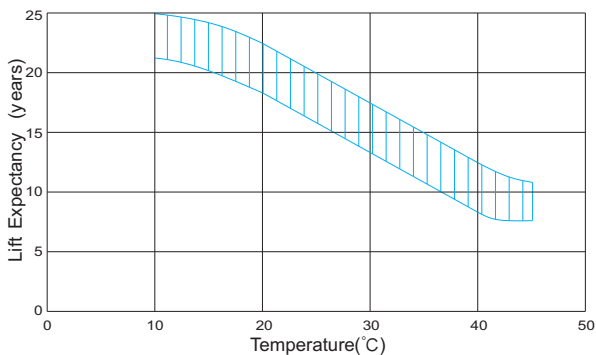

## Relationship of OCV And State of Charge(20°C)

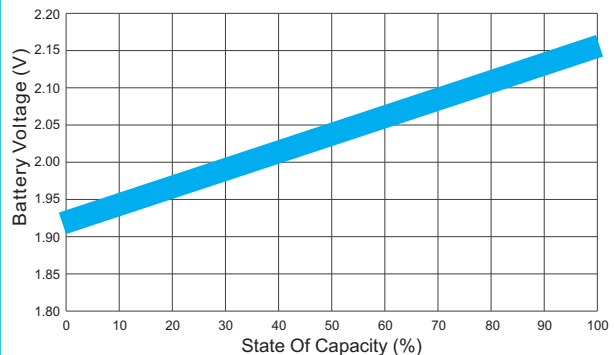

For Battery Sales + EPA Battery Recycling and AC / DC Power Services, please contact:  
**Moore & Moore Solutions, Inc.**  
 Phone: 484-302-7009  
 Email: [mr@mooreu.com](mailto:mr@mooreu.com)  
[www.MooreU.com](http://www.MooreU.com)