

OPzV2-250(2V250Ah)



Ritar OPzV series is Valve Regulated Lead Acid battery that adopts immobilized GEL and Tubular Plate technology to offer high reliability and performance. The Battery is designed and manufactured according to DIN standards and with die-casting positive grid and patented formula of active material OPzV series exceeds DIN standard values with more than 20 years floating design life at 25 °C ,and It is the best solution for cyclic use under extreme operating conditions.



Specification

Cells Per Unit	1
Voltage Per Unit	2
Nominal Capacity	250Ah@10hr-rate to 1.80V per cell @25°C
Weight	Approx. 20.5 Kg (Tolerance±2%)
Internal Resistance	Approx. 0.90 mΩ
Terminal	F10(M8)
Max. Discharge Current	1200A (5 sec)
Design Life	20 years (floating charge)
Maximum Charging Current	50.0 A
Reference Capacity	C3 189.2AH C5 212.5AH C10 250.0AH C20 267.8AH
Float Charging Voltage	2.25 V~2.30 V @ 25°C Temperature Compensation: -3mV/°C/Cell
Cycle Use Voltage	2.37 V~2.40 V @ 25°C Temperature Compensation: -4mV/°C/Cell
Operating Temperature Range	Discharge: -40°C~60°C Charge: -20°C~50°C Storage: -40°C~60°C
Normal Operating Temperature Range	25°C±5°C
Self Discharge	RITAR Valve Regulated Lead Acid (VRLA) batteries can be stored for up to 6 months at 25°C and then recharging is recommended. Monthly Self-discharge ratio is less than 2% at 25°C.Please charged batteries before using.
Container Material	A.B.S. UL94-HB, UL94-V0 Optional.

Dimensions

Unit: mm

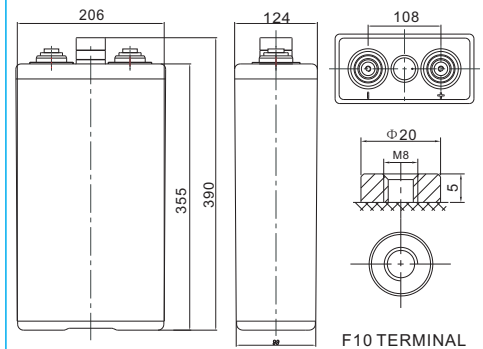

Length	124±2mm (4.88 inches)
Width	206±2mm (8.11 inches)
Height	355±2mm (14.0 inches)
Total Height	390±2mm (15.4 inches)
Torque Value	10~12 N*m

Constant Current Discharge Characteristics :A(25°C)

F.V/ Time	30min	1h	2h	3h	4h	5h	6h	8h	10h	20h
1.90	123.0	97.50	68.75	52.15	42.75	36.95	33.25	25.95	22.25	11.68
1.87	137.5	107.5	73.75	55.30	45.13	38.85	35.25	27.16	23.25	12.21
1.83	157.5	120.0	80.00	58.93	47.50	40.55	36.50	28.37	24.25	12.73
1.80	175.0	130.0	83.00	60.63	48.45	41.50	37.50	29.10	25.00	13.13
1.75	195.0	139.3	86.75	63.05	49.25	42.50	38.25	29.59	25.50	13.39
1.70	215.0	143.8	89.25	64.28	50.11	43.00	38.75	29.83	25.75	13.52
1.65	221.8	152.8	92.25	66.00	50.83	43.50	39.25	30.07	26.00	13.65
1.60	231.3	158.0	95.75	68.75	52.25	44.25	39.75	30.31	26.25	13.78

Constant Power Discharge Characteristics : WPC(25°C)

F.V/ Time	30min	1h	2h	3h	4h	5h	6h	8h	10h	20h
1.90	235.4	187.2	132.9	101.0	83.67	72.75	65.75	51.90	45.35	23.81
1.87	259.0	203.3	141.0	105.8	88.19	76.25	69.50	54.08	47.29	24.83
1.83	290.2	221.6	150.0	111.3	92.46	79.25	71.75	56.02	48.99	25.72
1.80	317.1	236.4	155.0	113.8	94.22	81.00	73.50	57.23	50.20	26.35
1.75	344.0	247.0	160.0	117.3	95.48	83.00	74.75	57.96	50.93	26.74
1.70	368.8	249.5	164.1	119.4	96.98	83.75	75.50	58.44	51.41	26.99
1.65	375.1	260.5	168.6	121.9	98.24	84.50	76.25	58.93	51.65	27.12
1.60	379.6	268.6	172.6	125.9	100.8	85.25	76.75	59.17	51.90	27.24

(Note) The above characteristics data are average values obtained within three charge/discharge cycle not the minimum values.

OPzV2-250(2V250Ah)



Discharge Characteristics Curve

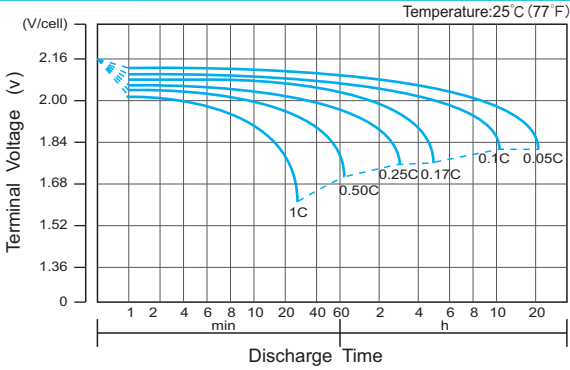

Charge Characteristic Curve for Cycle Use(IU)

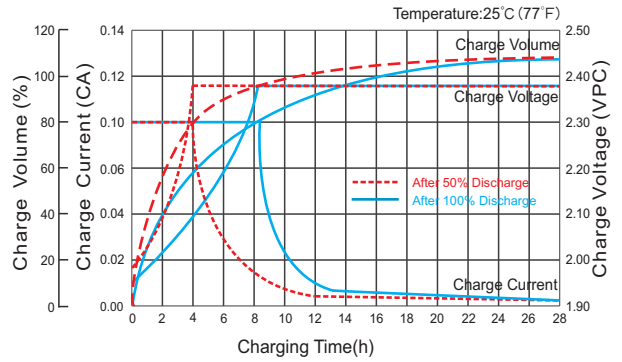

Cycle Life in Relation to Depth of Discharge

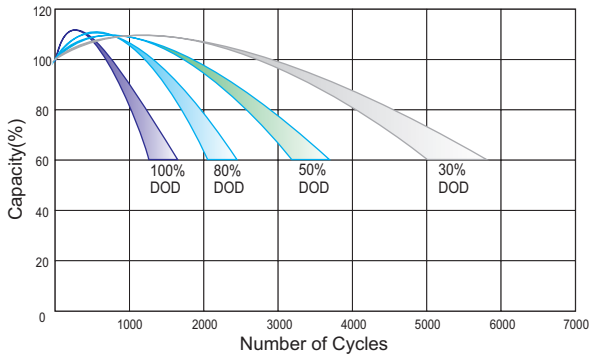

Relationship Between Charging Voltage and Temperature

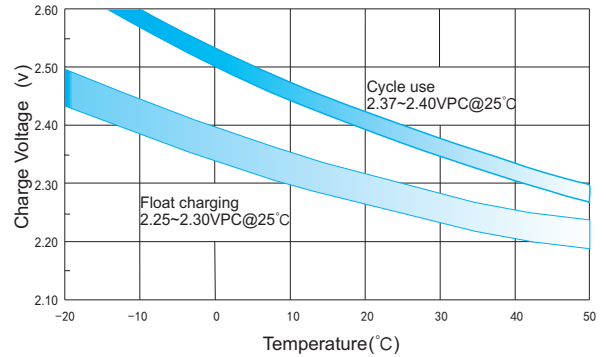

Temperature Effects on Capacity

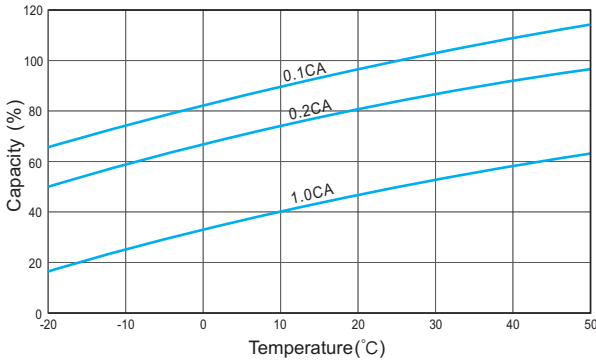

Storage Characteristics

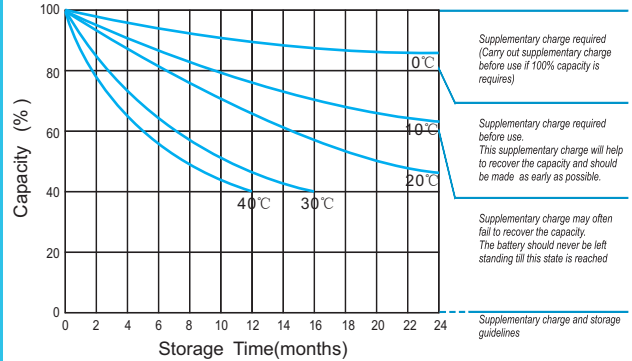

Effect of Temperature on Long Term Life

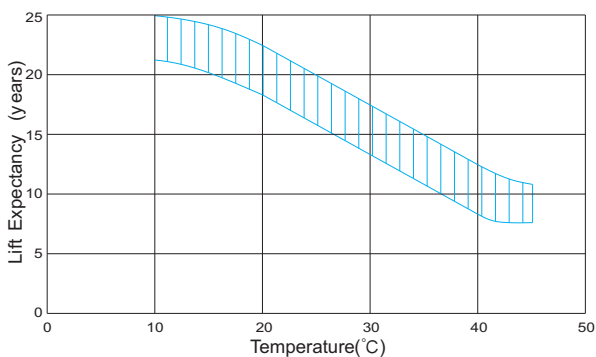

Relationship of OCV And State of Charge(20°C)

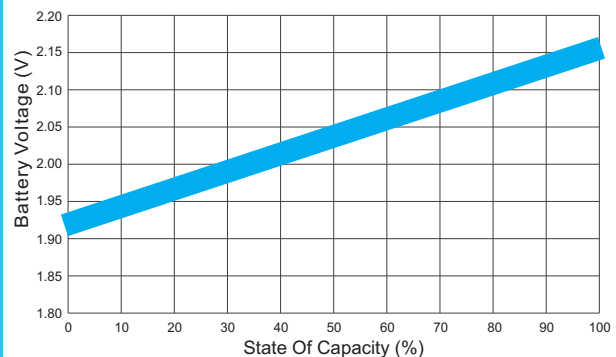

For Battery Sales + EPA Battery Recycling and AC / DC Power Services, please contact:
Moore & Moore Solutions, Inc.
Phone: 484-302-7009
Email: mr@mooreu.com
www.MooreU.com