

# OPzV12-45(12V45Ah)



Ritar OPzV series is Valve Regulated Lead Acid battery that adopts immobilized GEL and Tubular Plate technology to offer high reliability and performance. The Battery is designed and manufactured according to DIN standards and with die-casting positive grid and patented formula of active material OPzV series exceeds DIN standard values with more than 18 years floating design life at 25 °C ,and It is the best solution for cyclic use under extreme operating conditions.

## Specification

<b>Cells Per Unit</b>	6
<b>Voltage Per Unit</b>	12
<b>Nominal Capacity</b>	45Ah@10hr-rate to 1.80V per cell @25°C
<b>Weight</b>	Approx. 18.0 Kg (Tolerance±3%)
<b>Internal Resistance</b>	Approx. 19 mΩ
<b>Terminal</b>	F11(M6)/F15(M6)
<b>Max. Discharge Current</b>	450A (5 sec)
<b>Design Life</b>	18 years (floating charge)
<b>Maximum Charging Current</b>	9.0 A
<b>Reference Capacity</b>	C24 45.32AH C48 47.88AH C72 50.27AH C100 51.30AH C120 52.33AH C240 55.40AH
<b>Float Charging Voltage</b>	13.5 V~13.8 V @ 25°C Temperature Compensation: -3mV/°C/Cell
<b>Cycle Use Voltage</b>	14.2 V~14.4 V @ 25°C Temperature Compensation: -4mV/°C/Cell
<b>Operating Temperature Range</b>	Discharge: -40°C~60°C Charge: -20°C~50°C Storage: -40°C~60°C
<b>Normal Operating Temperature Range</b>	25°C±5°C
<b>Self Discharge</b>	RITAR Valve Regulated Lead Acid (VRLA) batteries can be stored for up to 6 months at 25°C and then recharging is recommended. Monthly Self-discharge ratio is less than 2% at 25°C.Please charged batteries before using.
<b>Container Material</b>	A.B.S. UL94-HB, UL94-V0 Optional.

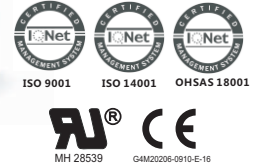

## Dimensions

Unit: mm

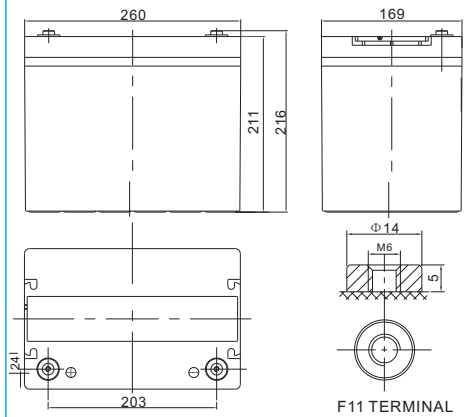

Length	260±2mm (10.2 inches)
Width	169±2mm (6.65 inches)
Height	211±2mm (8.31 inches)
Total Height	216±2mm (8.50 inches)
Torque Value	8~10 N*m

### Constant Current Discharge Characteristics : A(25°C)

F.V/ Time	30min	1h	2h	3h	4h	5h	6h	8h	10h	20h
1.90V	22.14	17.55	12.38	9.385	7.695	6.649	5.985	4.671	4.005	2.103
1.87V	24.75	19.35	13.28	9.952	8.123	6.995	6.345	4.889	4.185	2.197
1.83V	28.35	21.60	14.40	10.61	8.550	7.297	6.570	5.107	4.365	2.292
1.80V	31.50	23.40	14.94	10.91	8.721	7.470	6.750	5.238	4.500	2.363
1.75V	35.10	25.07	15.62	11.35	8.865	7.650	6.885	5.325	4.590	2.410
1.70V	38.70	25.88	16.07	11.57	9.020	7.740	6.975	5.369	4.635	2.433
1.65V	39.92	27.50	16.61	11.88	9.149	7.830	7.065	5.413	4.680	2.457
1.60V	41.63	28.44	17.24	12.38	9.405	7.965	7.155	5.456	4.725	2.481

### Constant Power Discharge Characteristics : WPC(25°C)

F.V/ Time	30min	1h	2h	3h	4h	5h	6h	8h	10h	20h
1.90V	42.38	33.70	23.92	18.18	15.07	13.10	11.84	9.342	8.163	4.285
1.87V	46.63	36.58	25.37	19.05	15.87	13.73	12.51	9.733	8.512	4.468
1.83V	52.23	39.88	27.00	20.03	16.65	14.27	12.92	10.08	8.817	4.628
1.80V	57.07	42.55	27.90	20.48	16.97	14.58	13.23	10.30	9.035	4.743
1.75V	61.92	44.45	28.80	21.12	17.18	14.94	13.46	10.43	9.167	4.812
1.70V	66.38	44.92	29.53	21.47	17.45	15.08	13.59	10.52	9.253	4.858
1.65V	67.52	46.90	30.35	21.95	17.68	15.21	13.73	10.61	9.297	4.882
1.60V	68.33	48.35	31.07	22.67	18.13	15.35	13.82	10.65	9.342	4.903

(Note) The above characteristics data are average values obtained within three charge/discharge cycle not the minimum values.

# OPzV12-45(12V45Ah)



## Discharge Characteristics Curve

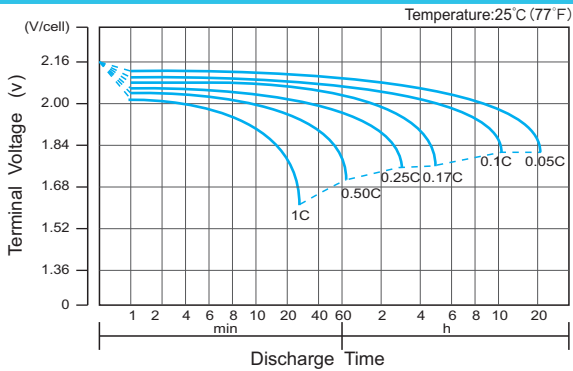

## Charge Characteristic Curve for Cycle Use(IU)

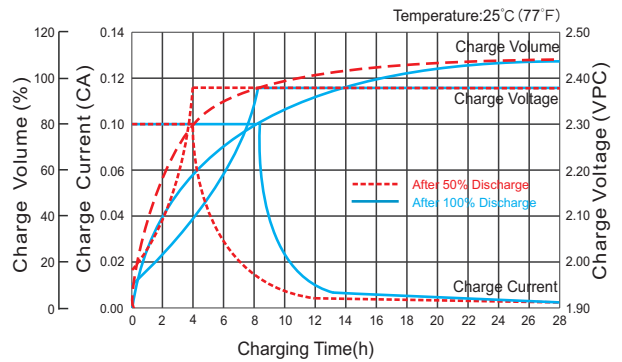

## Cycle Life in Relation to Depth of Discharge

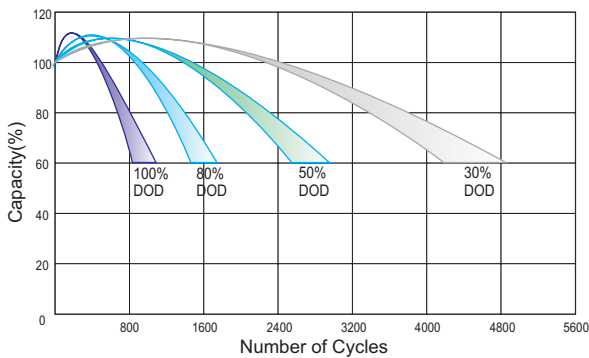

## Relationship Between Charging Voltage and Temperature

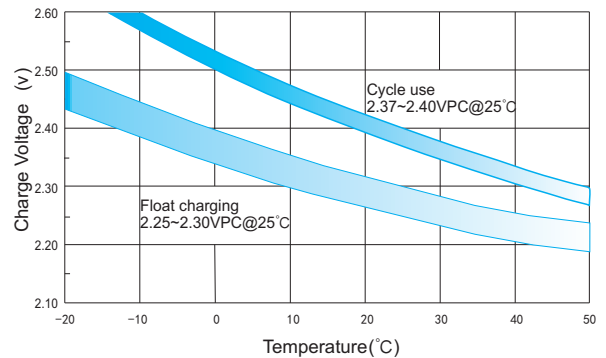

## Temperature Effects on Capacity

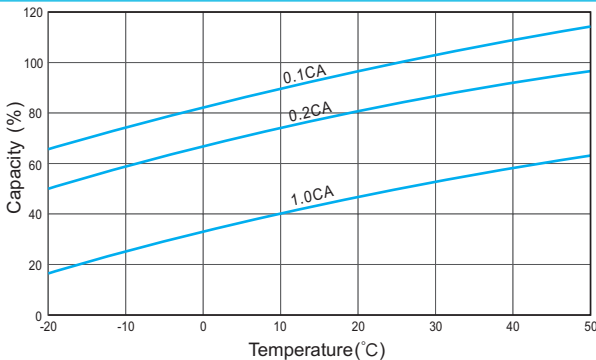

## Storage Characteristics

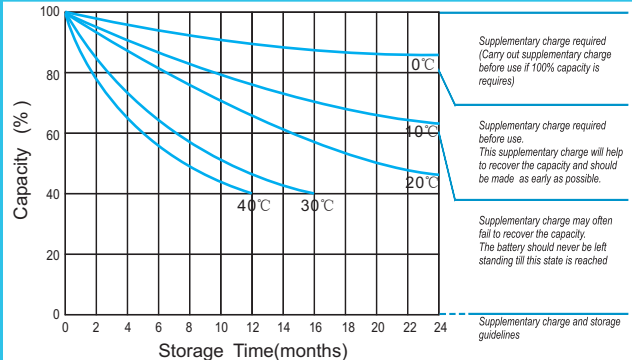

## Effect of Temperature on Long Term Life

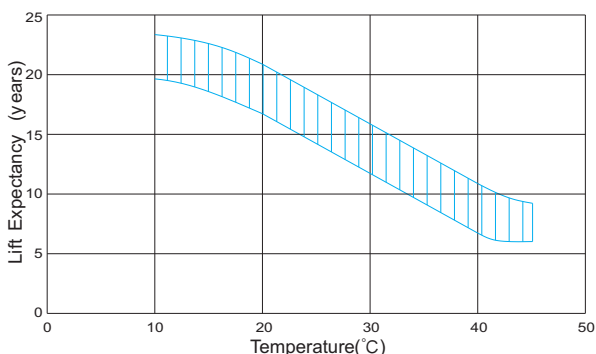

## Relationship of OCV And State of Charge(20°C)

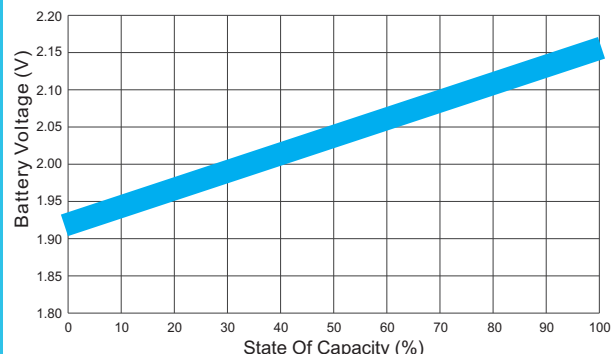

For Battery Sales + EPA Battery Recycling and AC / DC Power Services, please contact:  
**Moore & Moore Solutions, Inc.**  
**Phone: 484-302-7009**  
**Email: mr@mooreu.com**  
**www.MooreU.com**